

Power Supply Measurement and Analysis

Primer

Table of Contents

Introduction	3	Passive Component Measurements:	
Power Supply Design Questions		Magnetics	12 - 17
Point Toward Measurement Needs	3	Induction Basics	12
Switch-Mode Power Supply Basics	3 - 4	Making Induction Measurements with an Oscilloscope .	12
Active Component Measurements:		Magnetic Power Loss Basics	13
Switching Elements	4 - 11	Core Loss	13
Theory of Power Loss in Switch-Mode Devices	4	Copper Loss	13
Turn-Off Loss	4	Making Magnetic Power Loss Measurements	
Turn-On Loss	5	with an Oscilloscope	14
Power Loss	5	Magnetic Properties Basics	14
Safe Operating Area	6	B-H Plot	15
Dynamic On Resistance	6	Magnetic Property Measurements	16
Making Active Component Measurements	6	Measuring Magnetic Properties with an Oscilloscope ..	17
Choosing the Right Measurement Solution	7	Power Line Measurements	18 - 19
Performance Considerations For the Oscilloscope ..	7	Power Quality Measurements	18
Rise Time	7	Making Power Quality Measurements	
Sample Rate	7	with an Oscilloscope	19
Record Length	7	Conclusion	20
Power Measurement and Analysis Software	7	Product Comparison Chart	21
Eliminating Skew Between Voltage			
and Current Probes	9		
Eliminating Probe Offset and Noise	11		
Automated Offset Removal	11		
Manual Offset Removal	11		

Introduction

A power supply is a component, subsystem, or system that converts electrical power from one form to another; commonly from alternating current (AC) utility power to direct current (DC) power. The proper operation of electronic devices ranging from personal computers to military equipment and industrial machinery depends on the performance and reliability of DC power supplies.

There are many different kinds and sizes of power supplies from traditional analog types to high-efficiency switch-mode power supplies. All face a complex, dynamic operating environment. Device loads and demands can change dramatically from one instant to the next. Even a commodity switch-mode power supply must be able to survive sudden peaks that far exceed its average operating levels. Engineers designing power supplies or the systems that use them need to understand their supplies behavior under conditions ranging from quiescent to worst-case.

Historically, characterizing the behavior of a power supply has meant taking static current and voltage measurements with a digital multimeter and performing painstaking calculations on a calculator or PC. Today most engineers turn to the oscilloscope as their preferred power measurement platform.

Modern oscilloscopes can be equipped with integrated power measurement and analysis software which simplifies setup and makes it easier to conduct measurements over time. Users can customize critical parameters, automate calculations, and see results not just raw numbers in seconds.

This primer will focus on switch-mode power supply design measurements with an oscilloscope and application-specific software.

Power Supply Design Questions Point Toward Measurement Needs

Ideally every power supply would behave like the mathematical models used to design it. But in the real world, components are imperfect; loads vary; line power may be distorted; environmental changes alter performance. Moreover, changing performance and cost demands complicate power supply design. Consider these questions:

- How many watts beyond rated output capacity can the power supply sustain, and for how long?
- How much heat does the supply dissipate, what happens when it overheats, and how much cooling airflow does it require?
- What happens when the load current increases substantially? Can the device maintain its rated output voltage (load regulation)? How does the supply react to a dead short on its output?
- What happens when the supply's input voltage changes (line regulation)?

The designer is asked to create a power supply that takes up less space, is more efficient, reduces heat, cuts manufacturing costs, and meets tougher EMI/EMC standards. Only a rigorous regime of measurements can guide the engineer toward these goals.

Switch-Mode Power Supply Basics

The prevailing DC power supply architecture in most modern systems is the Switch-Mode Power Supply (SMPS), which is known for its ability to handle changing loads efficiently. The power signal path of a typical SMPS includes passive, active, and magnetic components. The SMPS minimizes the use of lossy components such as resistors and linear-mode transistors, and emphasizes components that are (ideally) lossless: switch-mode transistors, capacitors, and magnetics.

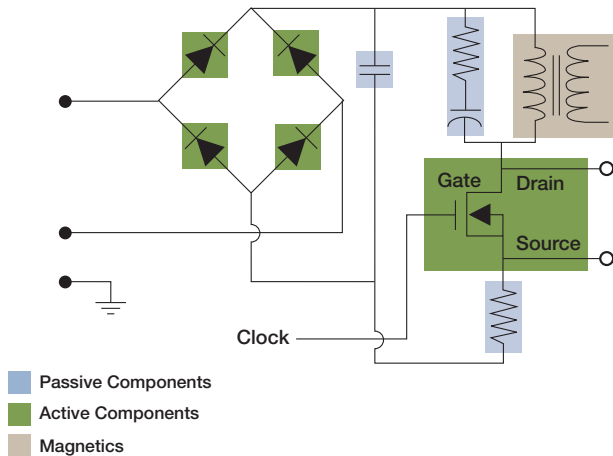

Figure 1. Switch-mode power supply simplified schematic.

SMPS devices also include a control section containing elements such as pulse-width-modulated regulators, pulse-rate-modulated regulators, and feedback loops.¹ Control sections may have their own power supplies. Figure 1 illustrates a simplified SMPS schematic showing the power conversion section with active, passive, and magnetic elements.

SMPS technology rests on power semiconductor switching devices such as Metal Oxide Semiconductor Field Effect Transistors (MOSFET) and Insulated Gate Bipolar Transistors (IGBT). These devices offer fast switching times and are able to withstand erratic voltage spikes. Equally important, they dissipate very little power in either the On or Off states, achieving high efficiency with low heat dissipation. For the most part, the switching device determines the overall performance of an SMPS. Key measurements for switching devices include: switching loss, average power loss, safe operating area, and more.

¹ This primer deals with measurements that pertain to the power path, including tests on internal elements that contribute to the output. Control section measurements are more conventional waveform- and logic-based observations and will not be covered in this document.

Active Component Measurements: Switching Elements

Theory of Power Loss in Switch-Mode Devices

Transistor switch circuits often dissipate the most energy during transitions because circuit parasitics prevent the devices from switching instantaneously. “Turn-off Loss” describes the loss when the device transitions from ON to OFF. “Turn-on Loss” describes the energy lost when the switching device transitions from OFF to ON.

Turn-Off Loss

Figure 2 diagrams the calculation of Turn-off loss. After t_1 , the switch current falls while the diode current rises. The time ($t_2 - t_1$) depends on how fast the driver can charge the gate-drain capacitance C_{gd} of the MOSFET.

Energy loss during the transition can be estimated by the following equation:

$$E_{off} = \frac{1}{2} \cdot V_g \cdot i_L \cdot [t_2 - t_0]$$

Where:

- E_{off} is the average energy loss in the switch during the transition.
- V_g is the voltage at the gate.
- i_L is the current through the inductor.
- t_2 is when the transition is complete.
- t_0 is when the transition begins.

This formula assumes the linear rise of voltage across C_{ds} (capacitance from drain to source) and C_{gd} , C_{ds} and C_{gd} are the parasitic capacitance.

In real-world devices, the capacitances C_{gd} and C_{ds} are highly non-linear, tending to vary with drain-source voltage. To some extent, this compromises the theoretical calculations just presented. In case of an IGBT, the fall time of current would be higher due to the tail current phenomenon. These differences make it essential to capture the actual profile of the voltage variation. An oscilloscope with dedicated power measurement software can greatly simplify these measurements.

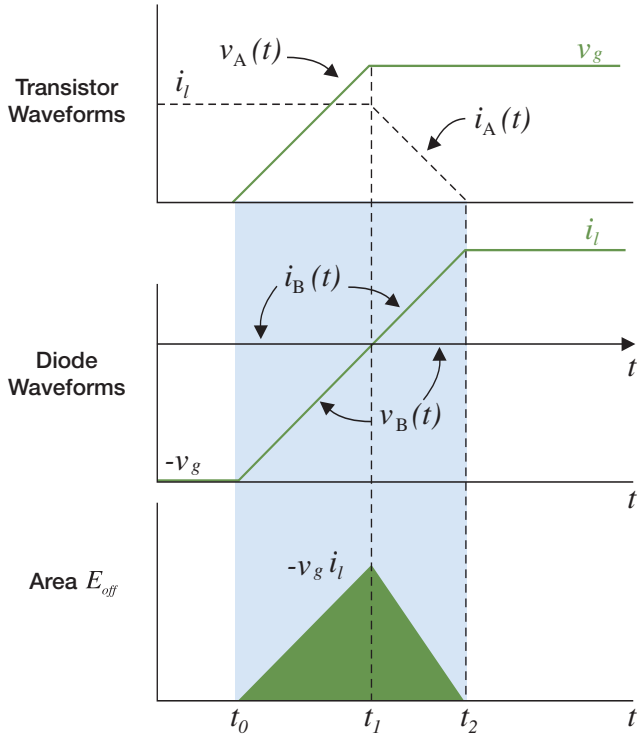

Figure 2. Calculation of Turn-off Loss.

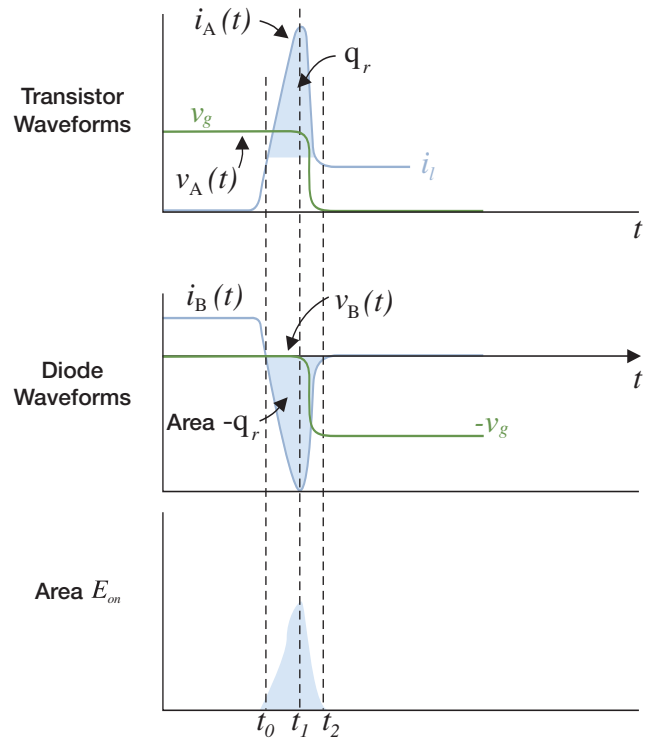

Figure 3. Turn-on Loss in a MOSFET with clamped inductive load.²

Turn-On Loss

Figure 3 shows the turn-on loss in a MOSFET with a clamped inductive load and with the diode recovery charge. When the MOSFET is turned on with a clamped inductive load, the diode voltage cannot build up until the stored charge is recovered. Therefore the diode continues to conduct current in the negative direction until it can block voltage. This leads to huge loss in the switch. The reverse recovery current depends on the external circuit in the diode path. The charge in the diode depends on the forward current and the di/dt of the fall current during the off transition of the diode.

Energy loss during the transition is estimated by the following equation:

$$E_{on} = \int_{t_0}^{t_1} v_a(t) \cdot i_a(t) \cdot dt$$

² Simplified and adapted from a presentation titled Fundamentals of Power Electronics, Robert A. Erickson, University of Colorado.

Where:

- E_{on} is the energy loss in the switch during the transition.
- $v_a(t)$ is the instantaneous gate voltage.
- $i_a(t)$ is the instantaneous current through the switch.
- t_1 is when the transition is complete.
- t_0 is when the transition begins.

Power Loss

The total loss is the average power loss in the switch. This includes the switching losses and conduction losses. The total loss is given by the formula

$$P_{Loss} = \frac{1}{T_s} \cdot \int_0^{T_s} V_{switch}(t) \cdot I_{switch}(t) \cdot dt$$

Where:

- P_{Loss} is the average power loss in the switch.
- $V_{switch}(t)$ is the instantaneous voltage across the switch.
- $I_{switch}(t)$ is the instantaneous current through the switch.
- T_s is the switching period.

Safe Operating Area

The Safe Operating Area (SOA) measurement on a switching device plots voltage vs. current to characterize the operating region of the device. It is often useful to create an SOA plot for the diverse operating conditions the power supply is expected to encounter.

The switching device manufacturer's data sheet summarizes certain constraints on the switching device. The object is to ensure that the switching device will tolerate the operational boundaries that the power supply must deal with in its end-user environment. SOA test variables may include various load scenarios, operating temperature variations, high and low line input voltages, and more. Figure 4 is an example of an SOA plot.

SOA tests usually calculate the Power using the following equation:

$$P_n = V_n I_n$$

Where:

- P_n is the instantaneous power.
- V_n is the voltage.
- I_n is the current.
- n is the sample number.

The following equation computes the Average Power:

$$P_{Avg} = \frac{1}{N} \sum_{n=0}^{n=N} V_n I_n$$

Where:

- N is the number of samples in a switching period.

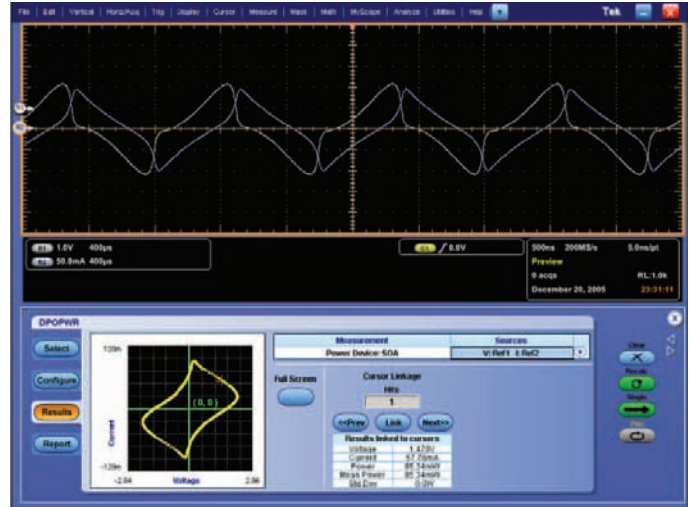

Figure 4. This example from Tektronix' DPOPOWER illustrates an SOA plot for an SMPS. The plot can be compared with the data published by the switching device manufacturer.

Dynamic On Resistance

The resistance of a switching device in the “on” state can be approximated by using the $R_{DS(on)}$ value found in the component's data sheet. However, the actual resistance (and therefore the switch conduction loss) is not constant and may vary significantly with changes in switch voltage or current.

di/dt and dv/dt

A di/dt measurement represents the rate at which the current changes during switching, while a dv/dt measurement represents the rate at which the voltage changes during switching.

Making Active Component Measurements

To those accustomed to making high-bandwidth measurements with an oscilloscope, power measurements, with their relatively low frequencies, might appear simple. In reality, power measurements present a host of challenges that the high-speed circuit designer never has to confront.

The voltage across a switching device can be very large, and is often “floating,” that is, not referenced to ground. There are variations in the pulse width, period, frequency, and duty cycle of the signal. Waveforms must be faithfully captured and analyzed for imperfections.

Choosing the Right Measurement Solution

For switch-mode power supply measurements, it is important to choose the tools that can do the job. To turn the SMPS on and off during test, a pulse stimulus from a signal source may be required. To accurately simulate the gate drive signal under normal operating conditions, the stimulus must have adjustable duty cycle, edge transition times, and frequency. To drive IGBT devices, the stimulus must also be able to generate the required voltage of typically 12 V to 15 V.

The oscilloscope must, of course, have the basic bandwidth and sample rate to handle the switching frequencies within an SMPS. And, it must have deep memory to provide the record length required for long, low-frequency acquisitions with high timing resolution. Power measurements also require at least two channels, one for voltage and one for current.

Equally important are the probes to connect the device to the oscilloscope. Multiple probe types – such as single-ended, differential, and current – are required simultaneously. Application software completes the toolset by making power measurements easier and more reliable.

Performance Considerations for the Oscilloscope

Key performance considerations when choosing an oscilloscope include rise time, sample rate, record length, and available power measurement analysis software.

Rise Time

Although the switching signal may be relatively low-speed, the rise time of the signal may be quite fast. For accurate measurements, the oscilloscope rise time should be at least five times as fast to capture the critical details of fast transitions.

$$RiseTime_{oscilloscope} = \frac{RiseTime_{SwitchingSignal}}{5}$$

For example, if the switching signal has a rise time of 5 ns, then the oscilloscope should have a rise time of at least 1 ns for accurate measurements. A rise time that fast is typically available on oscilloscopes with a bandwidth of at least 350 MHz.

Sample Rate

Sample rate – specified in samples per second (S/s) – refers to how frequently a digital oscilloscope takes a sample of the signal. A faster sample rate provides greater resolution and detail of the waveform, making it less likely that critical information or events will be lost. To characterize the ringing typical during switching in a SMPS, the oscilloscope's sample rate must be fast enough to capture several samples on the edges of the switching signal.

Record Length

An oscilloscope's ability to capture events over a period of time depends on the sample rate used and the depth (record length) of the memory that stores the acquired signal samples. The memory fills up in direct proportion to the sample rate. When the sample rate is set high enough to provide a detailed high-resolution view of the signal, the memory fills up quickly.

For many SMPS power measurements, it is necessary to capture a quarter-cycle or half-cycle (90 or 180 degrees) of the line frequency signal; some even require a full cycle.

A half-cycle of a 60 Hz line frequency is over 8 ms of time. At a sample rate of 1 GS/s, a record length of 8 million points is needed to capture that much time.

Power Measurement and Analysis Software

Application software can make power measurements and analysis on an oscilloscope much easier by automating common measurements, providing detailed test reports and simplifying certain complex measurement situations like measuring both high and low voltage signals for switching and power loss measurements.

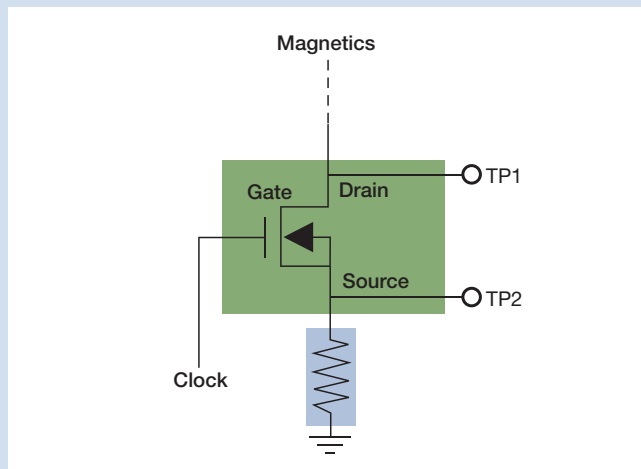

Figure 5. MOSFET switching device, showing measurement points.

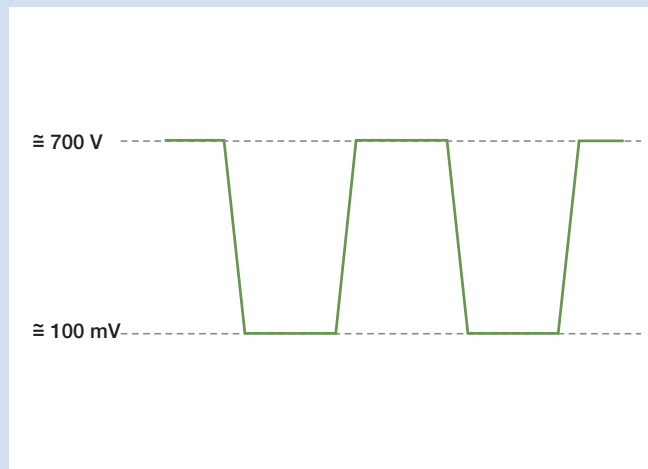

Figure 6. Typical signal of a switching device.

Measuring 100 Volts and 100 Millivolts in One Acquisition

To measure switching loss and average power loss across the switching device, the oscilloscope must first determine the voltage across the switching device during the OFF and ON times, respectively.

In an AC/DC converter, the voltage across the switching device has a very high dynamic range. The voltage across the switching device during the ON state depends upon the type of switching device. In the MOSFET illustrated in Figure 5, the ON voltage is the product of channel resistance and current. In Bipolar Junction Transistors (BJT) and IGBT devices, the voltage is primarily based on the saturation voltage drop ($V_{CE_{sat}}$). The OFF state voltage depends on the operating input voltage and the topology of the switch-mode converters. A typical DC power supply designed for computing equipment operates on universal utility voltage ranging from $80 V_{rms}$ to $264 V_{rms}$. At maximum input voltage, the OFF state voltage across the switching device (between TP1 and TP2) can be as high as 750 V. During the ON state, the voltage across the same terminals can range from a few millivolts to about one volt. Figure 6 shows the typical signal characteristics on a switching device.

These OFF and ON voltages must be measured first in order to make accurate power measurements on a



Figure 7. The DPOPWR input page allows the user to enter data sheet values for $R_{DS_{ON}}$ & $V_{CE_{sat}}$.

switching device. However, a typical 8-bit digital oscilloscope lacks the dynamic range to accurately acquire (within the same acquisition cycle) the millivolt-range signals during the ON time as well as the high voltages that occur during the OFF time.

To capture this signal, the oscilloscope's vertical range would be set at 100 volts per division. At this setting, the oscilloscope will accept voltages up to 1000 V; thus the 700 V signal can be acquired without overdriving the oscilloscope. The problem with using this setting is that the minimum signal amplitude it can resolve is $1000/256$, or about 4 V.

With the power application software offered with modern oscilloscopes, the user can enter $R_{DS_{ON}}$ or $V_{CE_{sat}}$ values from the device data sheet into the measurement menu, as shown in Figure 7. Alternatively, if the measured voltage is within the oscilloscope's sensitivity, then the application software can use acquired data for its calculations rather than the manually-entered values.

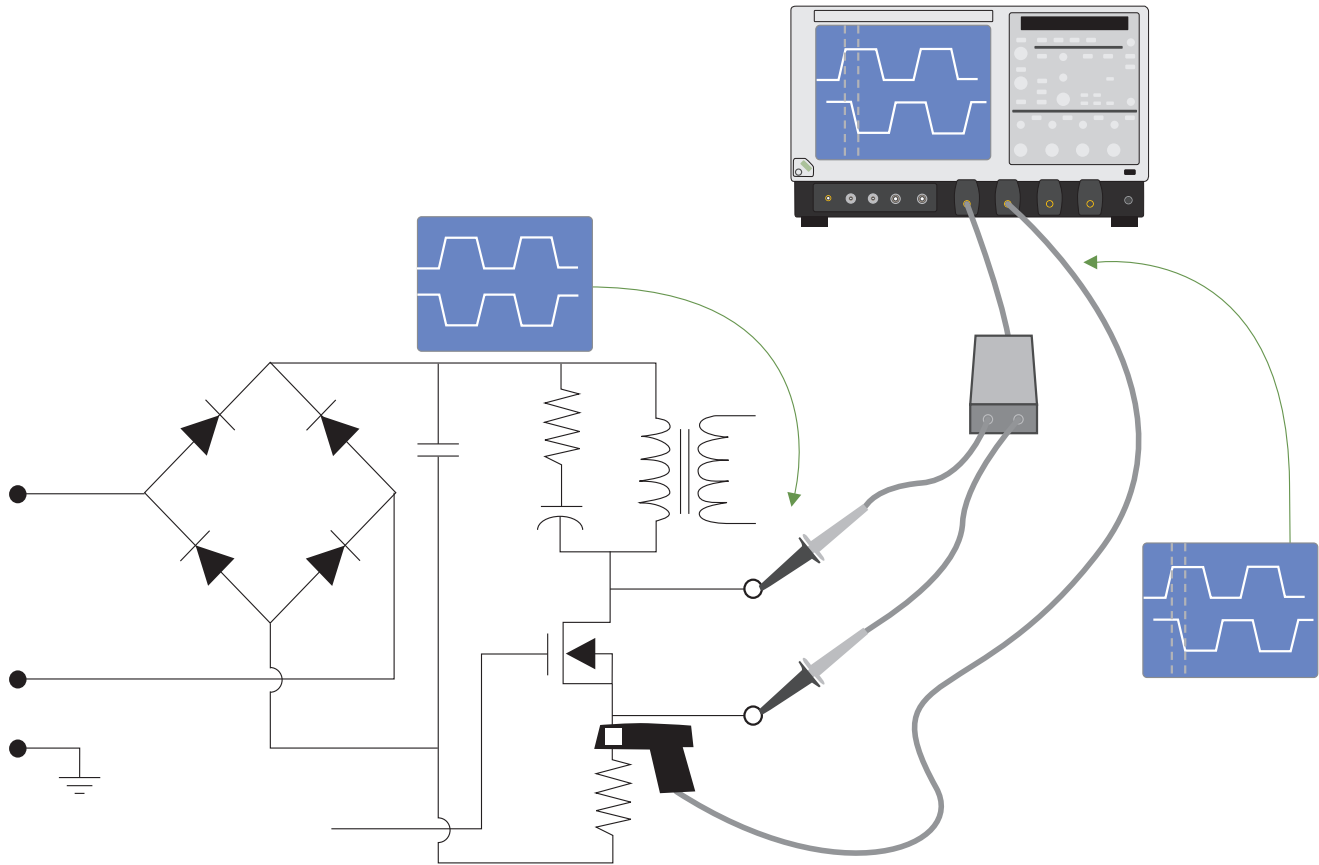

Figure 8. The effect of propagation delay on a power measurement.

Eliminating Skew Between Voltage and Current Probes

To make power measurements with a digital oscilloscope, it is necessary to measure voltage across and current through the drain-to-source of the MOSFET switching device or the collector-to-emitter voltage across an IGBT. This task requires two separate probes: a high-voltage differential probe and a current probe. The latter probe is usually a non-intrusive Hall Effect type. Each of these probes has its own characteristic propagation delay. The difference in these two delays, known as skew, causes inaccurate timing measurements and distorted power waveforms.

It is important to understand the impact of the probes' propagation delays on maximum peak power and area measurements. After all, power is the product of voltage and current. If the two multiplied variables are not perfectly time aligned, then the result will be incorrect. The accuracy of measurements such as switching loss suffer when the probes are not properly de-skewed.

The test setup shown in Figure 8 compares the signals at the probe tip (lower trace display) and at the oscilloscope front panel after the propagation delay (upper display).

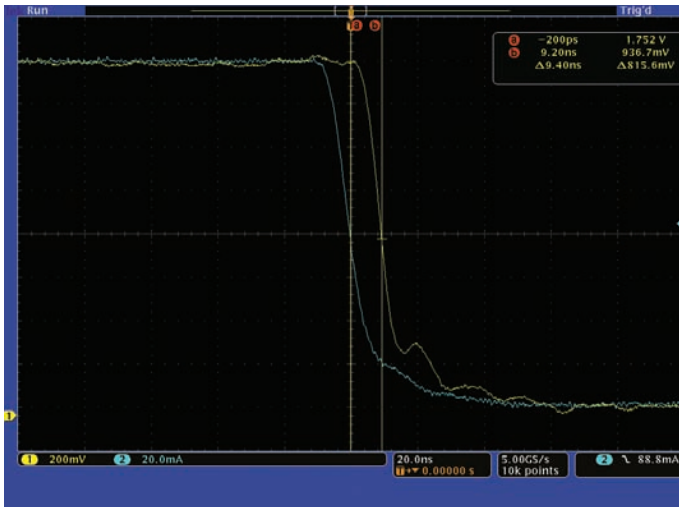

Figure 9. 9.4 ns skew between voltage and current signals.

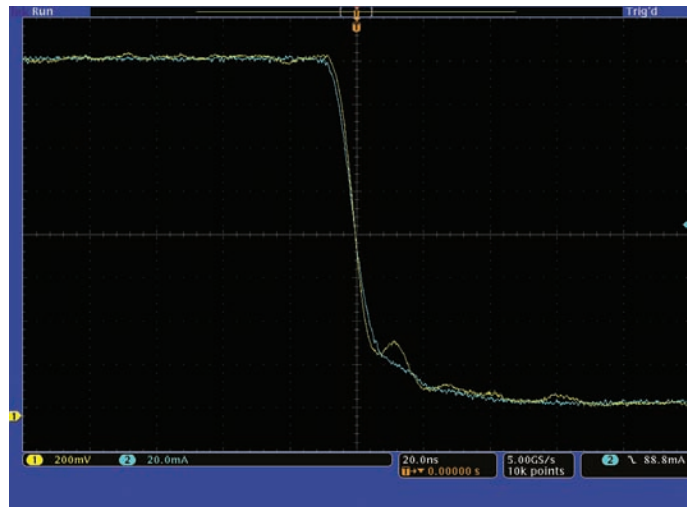

Figure 11. Voltage and current signals aligned after de-skew process.

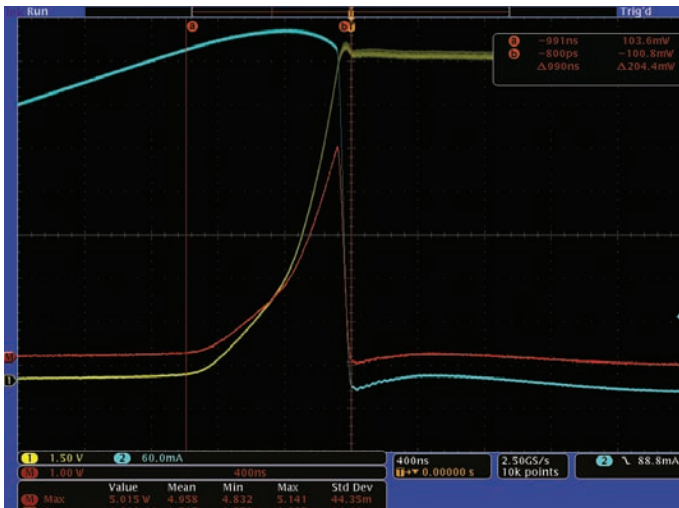

Figure 10. With skew, the peak amplitude of the power waveform is 4.958 W.

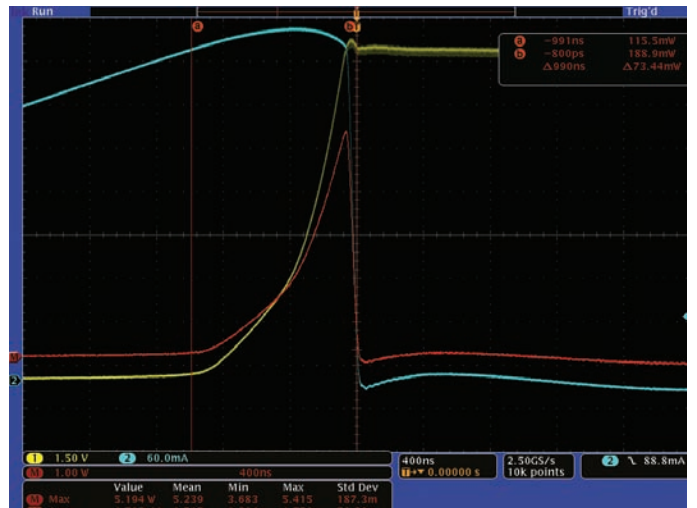

Figure 12. Peak amplitude has risen to 5.239 W (5.6% higher) after de-skew.

Figures 9 through 12 are actual oscilloscope screen views that demonstrate the effects of skew in probes. Figure 9 reveals the skew between the voltage and current probes, while Figure 10 displays the results (4.958 W) of a measurement taken without first de-skewing the two probes.

Figure 11 shows the effect of de-skewing the probes. The two reference traces are overlapping, indicating that the delays have been equalized. The measurement results in Figure 12 illustrate the importance of proper de-skewing. As the example proves, skew introduced a measurement error of 5.6%. Accurate de-skew reduces error in peak-to-peak power loss measurements.

Some power measurement software will automatically de-skew the chosen probe combination. The software takes control of the oscilloscope and adjusts the delay between the voltage and current channels using live current and voltage signals to remove the difference in propagation delay between the voltage and current probes.

Also available is a static de-skew function that relies on the fact that certain voltage and current probes have constant and repeatable propagation delays. The static de-skew function automatically adjusts the delay between selected voltage and current channels based on an embedded table of propagation times for selected probes. This technique offers a quick and easy method to minimize de-skew.

Eliminating Probe Offset and Noise

Differential and current probes may have a slight offset. This offset should be removed before taking measurements because it can affect accuracy. Some probes have a built-in, automated method for removing the offset while other probes require manual offset removal procedures.

Automated Offset Removal

A probe that is equipped with the Tektronix TekVPI™ Probe Interface works in conjunction with the oscilloscope to remove any DC offset errors in the signal path. Pushing the Menu button on a TekVPI probe brings up a Probe Controls box on the oscilloscope that displays the AutoZero feature.



Figure 13. Signal conditioning option on the TDSPOWER3 software menu. This selection sets the current to zero during the “Off” time of the switching device.

Selecting the AutoZero option will automatically null out any DC offset error present in the measurement system. A TekVPI current probe also has a Degauss/AutoZero button on the probe body. Depressing the AutoZero button will remove any DC offset error present in the measurement system.

Manual Offset Removal

Most differential voltage probes have built-in DC offset trim controls, which makes offset removal a relatively simple procedure. Similarly, it is necessary to adjust the current probe before making measurements.

Note that differential and current probes are active devices, and there will always be some low-level noise present, even in the quiescent state. This noise can affect measurements that rely on both voltage and current waveform data. Some power measurement software includes a signal-conditioning feature (Figure 13) that minimizes the effect of inherent probe noise.

Passive Component Measurements: Magnetics

Passive components are those which do not amplify or switch signals. Power supplies employ the full range of passive components such as resistors and capacitors, but from a measurement standpoint, the main focus is on the magnetic components (magnetics) particularly inductors and transformers. Both inductors and transformers consist of ferrous cores wound with turns of copper wire.

Inductors exhibit increasing impedance with frequency, impeding higher frequencies more than lower frequencies. This makes them useful for filtering current at the power supply input and the output.

Transformers couple voltage and current from a primary winding to a secondary winding, increasing or decreasing signal levels (either voltage or current but not both). Thus a transformer might accept 120 volts at its primary and step this down to 12 volts on the secondary with a proportional increase in current on the secondary. Note that this is not considered amplification because the signals net power does not increase. Because the transformers primary and secondary are not electrically connected, they are also used to provide isolation between circuit elements.

Some measurements that help to determine power supply performance include:

- Inductance
- Power Loss (Magnetic)
- Magnetic Properties

Inductance Basics

Power supplies use inductors as energy storage devices, filters, or transformers. As transformers, they help sustain oscillation in switched mode power systems. Designers need to monitor the behavior of this device under operating conditions. The inductance value depends on the current and voltage source, excitation signal, wave shape, and the frequency of operation. Inductance is defined as:

$$L = \frac{\int -V dt}{I}$$

Where:

- L is the inductance (Henry).
- V is the voltage across the inductor.
- I is the current through the inductor.
- dt is the rate of change in a signal; the slew rate.

There are several different solutions available for measuring inductance. The LCR meter, for example, excites the inductor under test using a built-in signal generator and then uses a bridge-balancing technique to measure the device impedance. The LCR meter uses a sinusoidal wave as the signal source.

In a real-world power supply, however, the signal is a high-voltage, high-current square wave. Therefore, most power supply designers prefer to get a more accurate picture by observing the inductors behavior in the dynamically changing environment of a power supply.

Making Inductance Measurements with an Oscilloscope

The most expedient tool for inductor measurements in a live power supply is an oscilloscope. The inductance measurement itself is as simple as probing the voltage across and the current through the magnetic component, much like the switching device measurements described earlier.

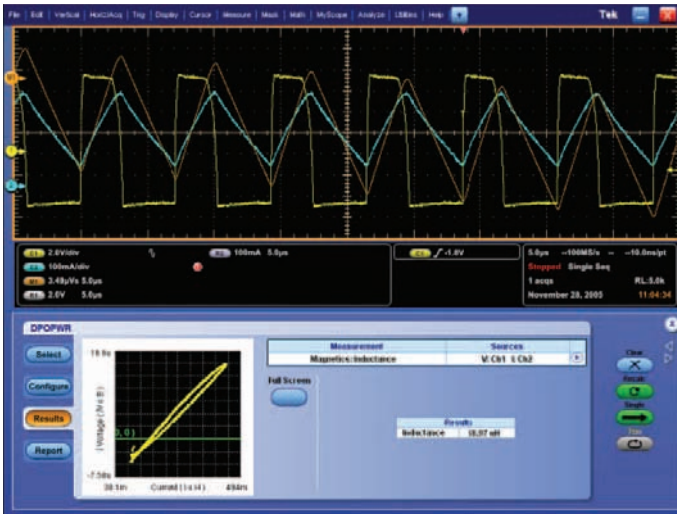

Figure 14. Inductance measurement results from DPOWPR application software.

Figure 14 shows the result of such an inductance measurement. Here, the software has computed the inductance to be 58.97 microhenries.

Magnetic Power Loss Basics

Magnetic power loss affects the efficiency, reliability, and thermal performance of the power supply. Two types of power losses are associated with magnetic elements: core loss and copper loss.

Core Loss

The core loss is composed of hysteresis loss and eddy current loss. The hysteresis loss is a function of the frequency of operation and the AC flux swing. It is largely independent of DC flux. The hysteresis loss per unit volume is expressed by the following equation:

$$P_{Hyst} = \int H \cdot dB$$

Where:

- P_{Hyst} is the hysteresis loss per unit volume.
- H is field strength.
- B is the flux density.

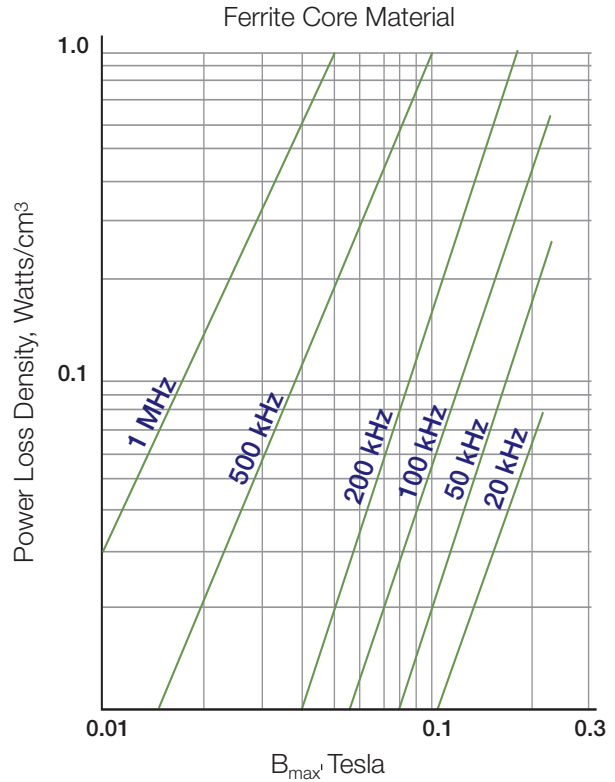

Figure 15. Plot of core loss vs. flux density at various switching frequencies.

It is possible to calculate the core loss using the core manufacturer’s data sheet such as that shown in the Figure 15. Here the manufacturer has specified the loss for sinusoidal excitation in the I and the III quadrant operation. The manufacturer also specifies an empirical relationship to calculate the core loss at different AC flux densities and frequency.

Copper Loss

The copper loss is due to the resistance of the copper winding wire. The copper loss is given by:

$$P_{cu} = I_{rms}^2 \cdot R_{wdg}$$

Where:

- P_{cu} is the copper loss.
- I_{rms} is the rms current through the magnetic component.
- R_{wdg} is the winding resistance. This resistance depends on the DC resistance, skin effect, and proximity effect.

Making Magnetic Power Loss Measurements with an Oscilloscope

The total power loss and the core loss can be quickly derived using information from the core vendor's data sheet and results from an oscilloscope running power measurement software. Use both values to calculate the copper loss. Knowing the different power loss components makes it possible to identify the cause for power loss at the magnetic component.

The method for calculating the magnetic component power loss depends in part on the type of component being measured. The device under test may be a single-winding inductor, a multiple-winding inductor, or a transformer. Figure 16 shows the measurement result for a single winding inductor.

Channel 1 (yellow trace) is the voltage across the inductor and Channel 2 (blue trace) is the current, measured with a non-intrusive current probe, through the inductor. The power measurement software automatically computes and displays the power loss figure, here shown as 173.95 milliwatts.

Multiple-winding inductors call for a slightly different approach. The total power loss is the sum of the losses from the individual windings:

$$TotalPowerLoss = PowerLoss_{L1} + PowerLoss_{L2} + PowerLoss_{L3} + \dots$$

Computing power loss at a transformer further varies the formula:

$$TotalPowerLoss = PowerLoss_{PR} - (PowerLoss_{S1} + PowerLoss_{S2} + \dots)$$

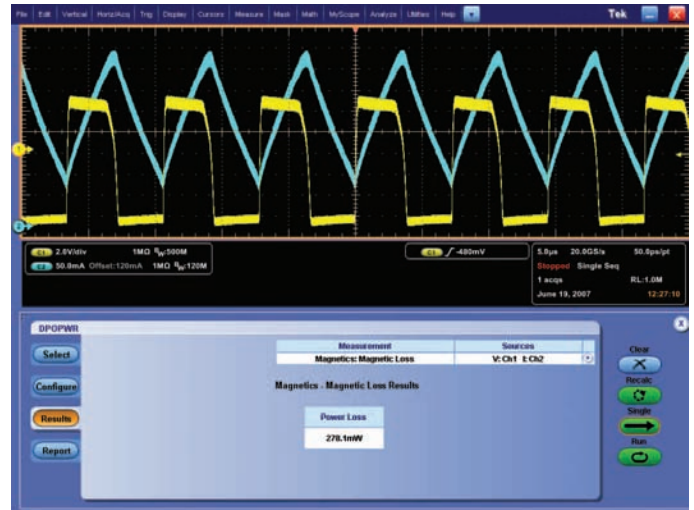

Figure 16. Power loss at single-winding inductor as measured by DPO/PWR.

The measured power loss at the primary winding will include the reflected power of the secondary winding. Therefore, it is necessary to measure power at the primary and secondary windings and compute the power loss using the transformer equation.

Magnetic Properties Basics

Switch-mode power supplies must be reliable over a wide range of operating conditions. For optimum performance, designers generally specify magnetic components, transformers and inductors, using B-H (hysteresis) curves supplied by the manufacturers. These curves define the performance envelope of the magnetic's core material. Factors including operating voltage, current, topology, and type of converter must be maintained within the linear region of the hysteresis curve. Obviously, with so many variables, this is not easy.

Characterizing the operating region of the magnetic component while it is operating within the SMPS is essential to determining the power supply's stability. The measurement procedure includes plotting the hysteresis loop and looking at the magnetic properties of the inductor and transformer.

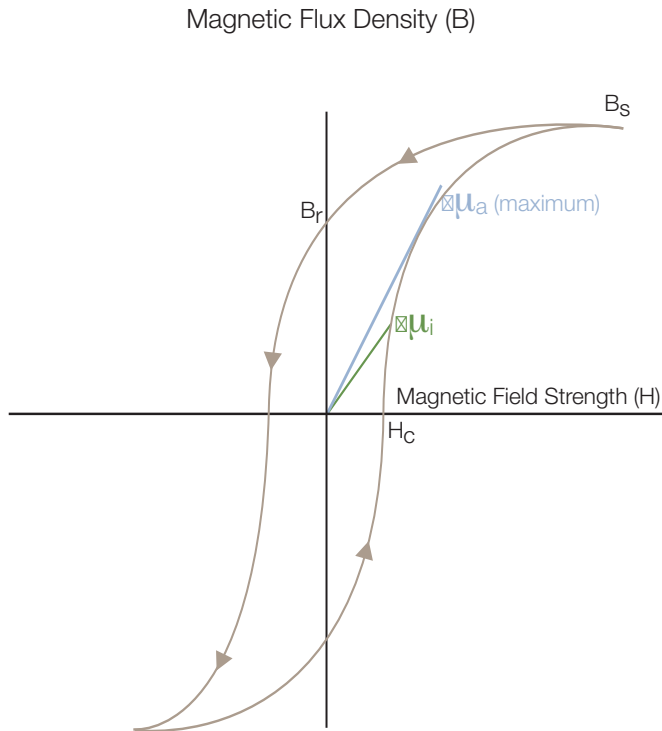

Figure 17. Typical B-H (hysteresis) plot of a magnetic component.

B-H Plot

The B-H plot characterizes the magnetic properties. Figure 17 shows a typical B-H plot for a sinusoidal excitation. To make B-H plot measurements, the following information is needed at the outset:

- Voltage across the magnetic component, V
- Magnetizing current, I
- Number of turns, N
- Magnetic Length, l
- Cross Sectional Area, A
- Surface Area, S

These variables are used in the following definitions that pertain to Figure 17:

Magnetic Field Strength (H) is the magnetic field used to induce magnetic flux in the material under test. Units are expressed in amperes per meter.

$$H_k(t) = I_k(t) \cdot \frac{N}{l}$$

Saturation Flux Density (B_s) is the maximum magnetic flux density that can be induced in the material regardless of the magnitude of the externally applied field H.

$$\varphi_k = \int V_k(t) dt$$

And:

$$B_k(t) = \frac{\varphi_k}{(N \cdot S)}$$

Remanence (B_r) is the induced magnetic flux density that remains in the material after the externally applied magnetic field (H) returns to zero while generating the hysteresis loop.

Coercive Force (H_c) is the value of H found at the intercept of the H-axis and the hysteresis loop. This represents the external field required to cause the induced flux density (B) to reach zero during the measurement cycle of a hysteresis loop. H_c is symmetrical with the positive and negative axes.

Initial Permeability (μ_i) is the ratio of induced magnetic flux densities (B) to apply field (H) as H approaches zero. It is the ratio of B to H at any point on the hysteresis loop. In addition, Maximum Amplitude Permeability is the maximum ratio of B to H on the first quadrant of the positive cycle of the hysteresis loop. It is the slope drawn from the origin.

Magnetic Property Measurements

Inductors are used as filters at the input and the output of the power supply, and may have single or multiple windings.

To make magnetic property measurements, the following information is necessary:

- Voltage across the magnetic component, V
- Magnetizing current, I
- Number of turns, N
- Magnetic Length, l
- Cross Sectional Area, A

The inductor voltage and current follow the following equation:

$$V_L(t) = R \cdot i_l(t) + L \cdot \frac{di_l(t)}{dt}$$

In a typical DC-to-DC converter, the flux in the winding is expressed by:

$$L \cdot \frac{di_L(t)}{dt} = N \cdot \frac{d\phi_L(t)}{dt}$$

and:

$$\Phi_L [(n+1)T_S] = \Phi_L [nT_S]$$

Figure 18 shows a typical multi-winding magnetic element that might be used as a coupled inductor or transformer. The electrical equations governing the operation of this circuit are as follows:

$$\frac{v_1(t)}{n_1} = \frac{v_2(t)}{n_2} = \frac{v_3(t)}{n_3}$$

and

$$i_1'(t) \cdot n_1 = - i_2(t) \cdot n_2 - i_3(t) \cdot n_3$$

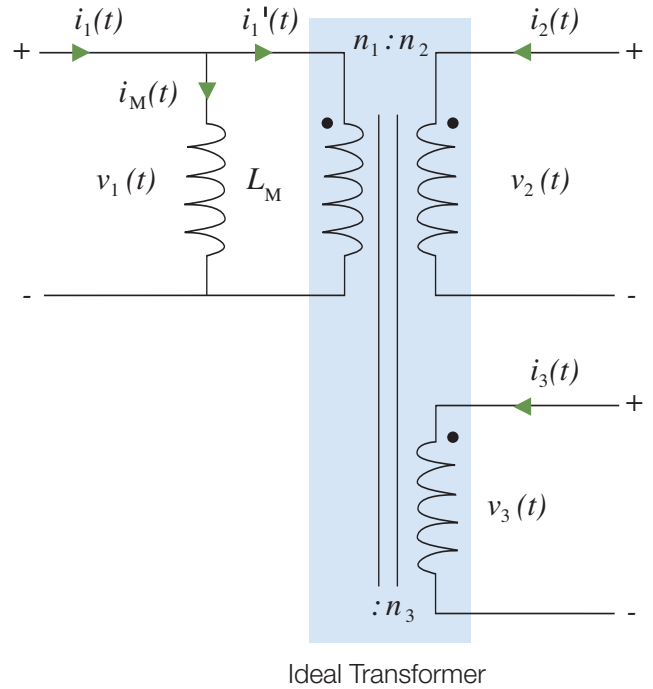

Figure 18. Multi winding magnetic element.

and

$$i_1(t) = i_M(t) + i_1'(t)$$

To calculate the net magnetizing current, it is necessary to measure $i_1(t)$, $i_2(t)$ and $i_3(t)$. Given the net magnetizing current, the B-H analysis procedure is similar to that used for a single-winding inductor. The flux depends upon the net magnetizing current. The vector sum of the measured currents in all the windings produces the magnetizing current.

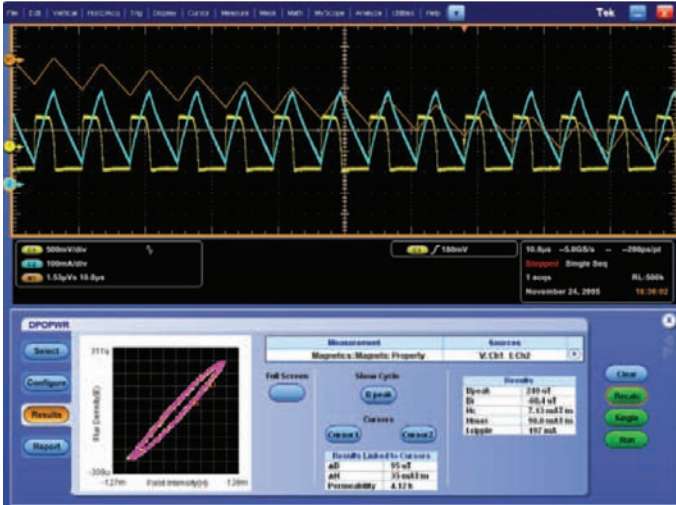

Figure 19. B-H plot for single winding inductor.

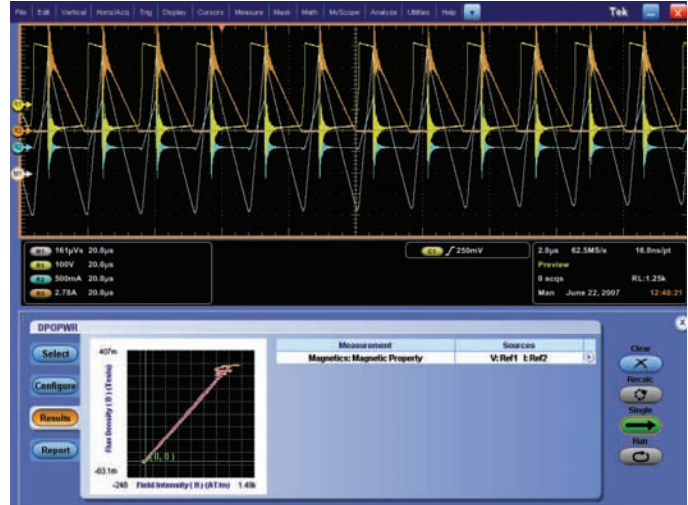

Figure 20. B-H plot for transformer.

Measuring Magnetic Properties with an Oscilloscope

Dedicated power measurement software can greatly simplify magnetic properties measurements with an oscilloscope. In many instances, it is necessary only to measure the voltage and magnetizing current. The software performs the magnetic property measurement calculations for you. Figure 19 depicts the results of a magnetic property measurement on a single-winding inductor. The measurement can also be performed on a transformer with a primary and secondary current source.

In Figure 20, Channel 1 (yellow trace) is the voltage across the transformer, Channel 2 (blue trace) is the current through the primary, and Channel 3 (magenta trace) is current through the secondary. Using Channel 2 and Channel 3 data, the software determines the magnetizing current.

Some power measurement software can also create an exact B-H plot for the magnetic component and characterize its performance. The number of turns, the magnetic length and the cross-sectional area of the core must first be entered before the software can compute a B-H plot.

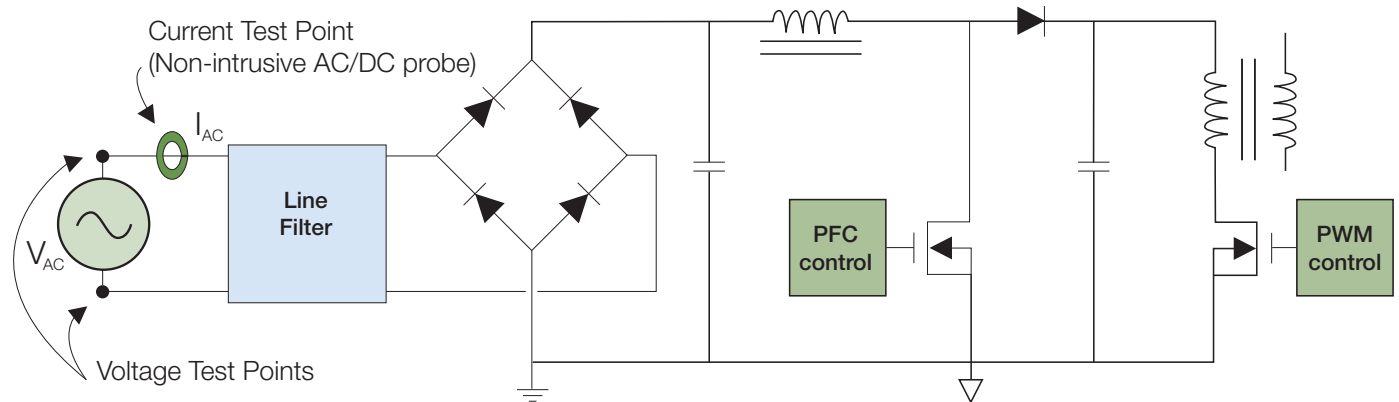

Figure 21. Simplified view of an SMPS power supply (primary side only) and its power quality measurement test points. Simultaneous input V_{AC} and I_{AC} readings are necessary for power quality measurements.

Power Line Measurements

Power line measurements characterize the interaction of the supply and its service environment. It is good to remember that power supplies can be of any size, from the small fan-feed boxes inside a personal computer, to the sizeable devices supplying factory motors, to the massive supplies supporting phone banks and server farms. Each of these has some effect on the incoming power source (typically utility power) that feeds it.

To determine the effect of the insertion of the power supply, power voltage and current parameters must be measured directly on the input power line.

Power Quality Measurement Basics

Power quality does not depend on the electricity producer alone. It also depends on the design and manufacture of the power supply and on the end-user's load. The power quality characteristics at the power supply define the "health" of the power supply.

Real-world electrical power lines never supply ideal sine waves. There is always some distortion and impurity on the line. A switching power supply presents a non-linear load to the source. Because of this, the voltage and current waveforms are not identical. Current is drawn for some portion of the input cycle, causing the generation of harmonics on the input current waveform. Determining the effects of these distortions is an important part of power engineering.

To determine the power consumption and distortion on the power line, power quality measurements are made at the input stage, as shown by the voltage and current test points in Figure 21.

Power quality measurements include:

- True Power
- Apparent Power or Reactive Power
- Power Factor
- Crest Factor
- Current Harmonics Measurements to EN61000-3-2 Standards
- Total Harmonic Distortion (THD)

Making Power Quality Measurements with an Oscilloscope

Digital oscilloscopes running power measurement application software are a powerful alternative to the power meters and harmonic analyzers traditionally used for power quality measurements.

The benefits of using an oscilloscope rather than the older toolset are compelling. The instrument must be able to capture harmonic components up to the 50th harmonic of the fundamental. Power line frequency is usually 50 Hz or 60 Hz, according to applicable local standards. In some military and avionics applications, the line frequency may be 400 Hz. And of course, signal aberrations may contain frequencies that are higher yet. With the high sampling rate of modern oscilloscopes, fast-changing events are captured with great detail (resolution). In contrast, conventional power meters can overlook signal details due to their relatively slow response time. And, the oscilloscope's record length is sufficient to acquire an integral number of cycles, even at very high sampling resolution.

Software tools speed measurement procedures and minimize setup time. Most power quality measurements can be automated by full-featured power measurement software running on the oscilloscope itself, performing lengthy procedures in seconds. By reducing the number of manual calculations, the oscilloscope acts as a very versatile and efficient power meter. Figure 22 shows an example of robust power measurement software.

The oscilloscope probes, too, assist in safe, reliable power measurements. High-voltage differential probes designed for power applications are the preferred tools for observing floating voltage signals.

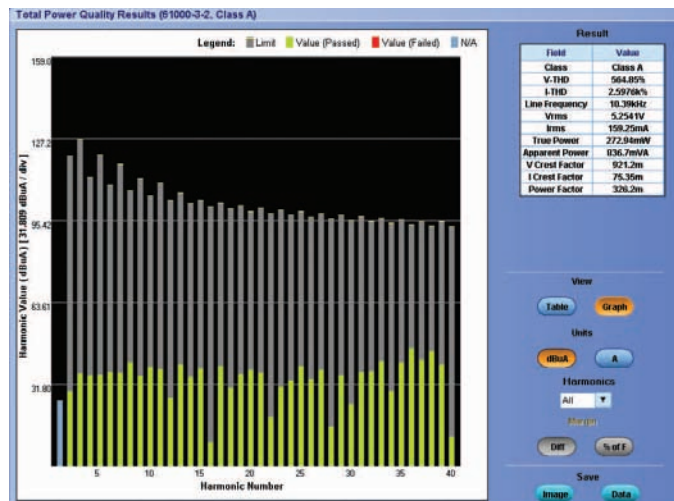

Figure 22. Power quality results using DPOPWR Measurement and Analysis Software. Measurements include True Power, Apparent Power, Crest Factor, Total Harmonic Distortion, Power Factor, plus a bar graph display of current harmonics.

Current probing is a special consideration. There are several implementations of current probing architecture:

- The AC current probe is based on current transformer (CT) technology. The CT probe is non-intrusive but cannot sense the DC component in the signal, which can result in inaccurate measurements.
- The current shunt. This design requires interrupting the circuit and can cause a voltage drop within the probe itself, potentially compromising power measurement accuracy.
- The AC/DC current probe is typically based on Hall-Effect sensor technology. This device senses AC/DC current non-intrusively and is able to read the both the AC and the DC components with one connection.

The AC/DC current probe has become the tool of choice for challenging power quality measurements in switch-mode power supplies.

Conclusion

The power supply is integral to virtually every type of line-powered electronic product, and the switch-mode power supply (SMPS) has become the dominant architecture in digital computing, networking, and communications systems. A single switch-mode power supply's performance or its failure can affect the fate of a large, costly system.

Measurements are the only way to ensure the reliability, stability, compliance, and safety of an emerging SMPS design. SMPS measurements fall into three principal categories: active device measurements; passive device measurements (mostly magnetics); and power quality tests. Some measurements may deal with floating voltages and high currents; others require math-intensive analysis to deliver meaningful results. Power supply measurements can be complex.

The modern digital oscilloscope has become the tool of choice for characterization and troubleshooting measurements. When equipped with appropriate probing tools and automated measurement software, the oscilloscope simplifies challenging SMPS measurements while providing fast, accurate answers.

Power Measurements

Which Tektronix instrument is right for your power applications?

- Automatic
- Manual



Specifications	Bandwidth	100 MHz to 200 MHz	100 MHz to 500 MHz	100 MHz to 1 GHz	350 MHz to 1 GHz	500 MHz to 3.5 GHz
	Record Length	2.5 k	10 k	Up to 10 M	Up to 16 M	Up to 200 M
	Sample Rate	Up to 2 GS/s	Up to 5 GS/s	Up to 5 GS/s	Up to 5 GS/s ^{*1}	Up to 40 GS/s ^{*1}
	Maximum Input Voltage (see Voltage Probes, page 22)	300 V _{RMS} CAT II	150 V _{RMS}	250 V _{RMS} , 400 V _{pk-pk}	150 V CAT I	150 V CAT I
Special Features	Automated De-skew			X	X	X
	Isolated and Floating Channels	X				
	Windows Operating System and Desktop				X	X
	Battery Powered Operation	X	X			
	FFT Plots	X	X	X	X	X
Line Power Quality Measurements	V _{RMS}	■	■	■	■	■
	I _{RMS}	■	■	■	■	■
	True (Real) Power	■	■	■	■	■
	Reactive Power	■		■	■	■
	Apparent Power	■	■	■	■	■
	Power Factor	■	■	■	■	■
	Crest Factor	■	■	■	■	■
	Phase Angle	■	■	■	■	■
	Harmonics	■	■	■	■	■
Total Harmonic Distortion	■		■	■	■	
I/O Analysis Measurements	Line Ripple	■	■	■	■	■
	Switching Noise	■	■	■	■	■
Emission Compliance Tests	Pre-Compliance Testing to EN61000-3-2	■		■	■	■
	MIL Standard 1399	■		■	■	■
Active Component Measurements	Switching Loss Measurements	■	■	■	■	■
	Safe Operating Area	■	■	■	■	■
	Dynamic Resistance (dv/dt, di/dt)	■	■	■	■	■
	Modulation Analysis			■	■	■
Passive Component Measurements	Inductance				■	■
	Magnetic Power Loss				■	■
	Flux Density			■	■	■
	B-H Plots				■	■

*1 On One Channel

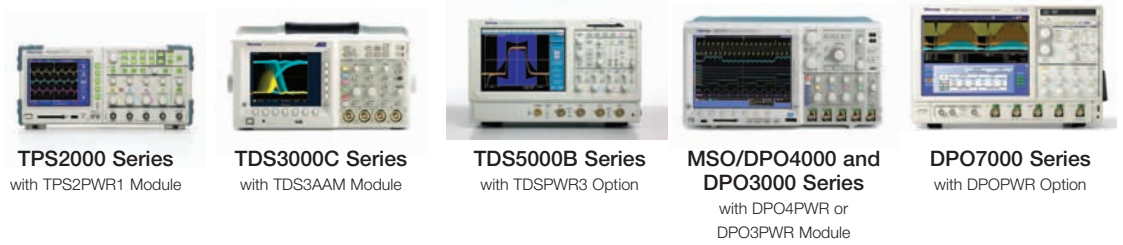

TPS2000 Series
with TPS2PWR1 Module

TDS3000C Series
with TDS3AAM Module

TDS5000B Series
with TDSPWR3 Option

MSO/DPO4000 and DPO3000 Series
with DPO4PWR or DPO3PWR Module

DPO7000 Series
with DPOPWR Option

<p>Power Applications</p>	<ul style="list-style-type: none"> ■ Industrial Power ■ Automotive 	<ul style="list-style-type: none"> ■ Power Supply Troubleshooting ■ Education 	<ul style="list-style-type: none"> ■ SMPS Design & Development ■ Pre-Compliance (Military and Industrial) 	<ul style="list-style-type: none"> ■ Power Supply Troubleshooting ■ SMPS Design & Development 	<ul style="list-style-type: none"> ■ SMPS Design & Development ■ Pre-compliance (Military and Industrial) 	
<p>Probes</p>	<p>The TPS2000, TDS3000C and TDS5000B Series oscilloscopes achieve the best power measurement performance when combined with the following probes.</p> <div data-bbox="402 726 711 978" data-label="Image"> </div> <p>High Voltage Differential Probes</p> <p>Features</p> <ul style="list-style-type: none"> ■ Safely make measurements of floating or elevated circuits with the oscilloscope grounded. ■ Wide dynamic voltage range from milli-Volts to kilo-Volts. <p>Model Numbers</p> <ul style="list-style-type: none"> - P5205 (measures up to 1000 V_{RMS} CAT II) - P5210¹ (measures up to 4400 V_{RMS}) <div data-bbox="402 1192 776 1381" data-label="Image"> </div> <p>Current Probes</p> <p>Features</p> <ul style="list-style-type: none"> ■ Transformer and Hall effect technology enhance AC/DC measurement capabilities. ■ Wide dynamic current range from milli-Amps to kilo-Amps. <p>Model Numbers</p> <ul style="list-style-type: none"> - TCP202 - TCPA300 with TCP303, TCP305, and/or TCP312 			<p>The MSO/DPO4000, DPO3000 and DPO7000 Series digital phosphor oscilloscopes are equipped with the Tektronix Versatile Probe Interface (TekVPI). TekVPI™ probes are versatile, feature-rich, and easy-to-use.</p> <div data-bbox="1101 779 1312 968" data-label="Image"> </div> <p>TekVPI High Voltage Differential Probes</p> <p>Features</p> <ul style="list-style-type: none"> ■ Offers GHz performance to analyze Switch Mode Power Supply (SMPS) designs. ■ Versatile device under test (DUT) connectivity and ease-of-use. <p>Model Numbers</p> <ul style="list-style-type: none"> - TDP1000² - TDP0500² <div data-bbox="1101 1199 1442 1356" data-label="Image"> </div> <p>TekVPI Current Probes</p> <p>Features</p> <ul style="list-style-type: none"> ■ Exceptional bandwidth (DC to 120 MHz) and broad dynamic range (milli-Amps to hundreds of Amps.) ■ Split core construction makes it easier and quicker to connect to the device under test (DUT). <p>Model Numbers</p> <ul style="list-style-type: none"> - TCP0030² 		

*1 TPS2000 Series requires 1103 power supply.

*2 DPO3000 Series requires TekVPI external power supply 119-7465-XX when total oscilloscope probe power usage exceeds 20W.

Power Measurement And Analysis Application Software

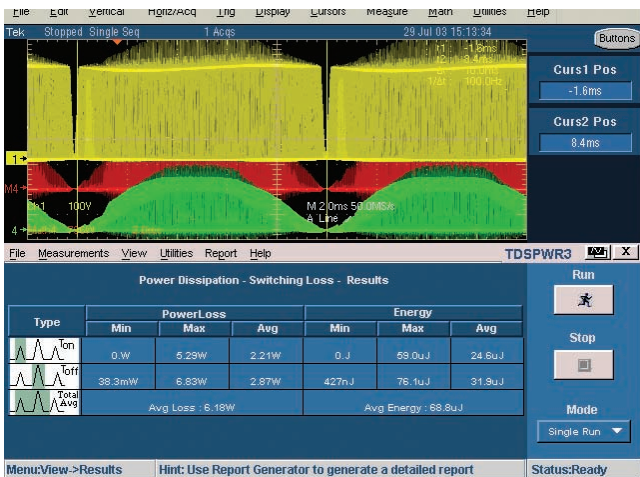

DPO4PWR for the DPO7000 Series Oscilloscope

- Multi-vendor probe support with auto-deskew capability
- Quickly measure and analyze power dissipation in power supply switching devices and magnetic components
- Generate detailed test reports in customizable formats

TDSPWR3 for the TDS5000B Series Oscilloscope

- TEKPROBE™ probe support with auto-deskew capability
- Quickly measure and analyze power dissipation in power supply switching devices and magnetic components
- Generate detailed test reports in customizable formats

DPO4PWR for the MSO/DPO4000 Series and DPO3PWR for the DPO3000 Series Oscilloscope

- TekVPI probe support with auto-deskew capability
- Quickly measure and analyze power quality, switching loss, harmonics, SOA, modulation, ripple and slew rate in power supply switching devices

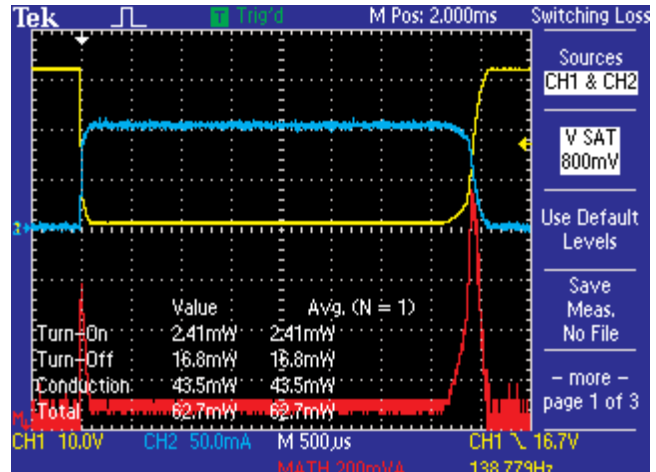

TPS2PWR1 for the TPS2000 Series Oscilloscope

Quickly measure and analyze instantaneous power, harmonics, switching loss, phase angles, dv/dt and di/dt

Complete Your Measurement Solution with a Signal Source



AFG3000 Series Arbitrary/Function Generator

Save cost and set-up time by creating high amplitude signals to stimulate your device without using an external power amplifier. The AFG3011 offers up to 20 Vp-p amplitude (into a 50 Ω load) at frequencies up to 10 MHz. Other models of the AFG3000 Series offer frequencies up to 240 MHz with one or two channels to create up to two synchronized or completely independent signals.

Contact Tektronix:

ASEAN / Australasia (65) 6356 3900
Austria +41 52 675 3777
Balkans, Israel, South Africa and other ISE Countries +41 52 675 3777
Belgium 07 81 60166
Brazil +55 (11) 40669400
Canada 1 (800) 661-5625
Central East Europe, Ukraine and the Baltics +41 52 675 3777
Central Europe & Greece +41 52 675 3777
Denmark +45 80 88 1401
Finland +41 52 675 3777
France +33 (0) 1 69 86 81 81
Germany +49 (221) 94 77 400
Hong Kong (852) 2585-6688
India (91) 80-42922600
Italy +39 (02) 25086 1
Japan 81 (3) 6714-3010
Luxembourg +44 (0) 1344 392400
Mexico, Central/South America & Caribbean 52 (55) 54247900
Middle East, Asia and North Africa +41 52 675 3777
The Netherlands 090 02 021797
Norway 800 16098
People's Republic of China 86 (10) 6235 1230
Poland +41 52 675 3777
Portugal 80 08 12370
Republic of Korea 82 (2) 6917-5000
Russia & CIS +7 (495) 7484900
South Africa +27 11 206 8360
Spain (+34) 901 988 054
Sweden 020 08 80371
Switzerland +41 52 675 3777
Taiwan 886 (2) 2722-9622
United Kingdom & Ireland +44 (0) 1344 392400
USA 1 (800) 426-2200
For other areas contact Tektronix, Inc. at: 1 (503) 627-7111
Updated 30 October 2008

For Further Information

Tektronix maintains a comprehensive, constantly expanding collection of application notes, technical briefs and other resources to help engineers working on the cutting edge of technology. Please visit www.tektronix.com



Copyright © 2009, Tektronix. All rights reserved. Tektronix products are covered by U.S. and foreign patents, issued and pending. Information in this publication supersedes that in all previously published material. Specification and price change privileges reserved. TEKTRONIX and TEK are registered trademarks of Tektronix, Inc. All other trade names referenced are the service marks, trademarks or registered trademarks of their respective companies.
01/09 EA/ 55W-18412-3

Tektronix[®]
Enabling Innovation

